



Health & Safety, Use & Care, Installation Guide

Models:

VWED9002IG
VWED1102IG
VWED1202IG

- Please read this manual carefully before using this machine, and please keep it in a safe place.
- When the washing machine is not in use, the water tap must be turned off and the power cord must be unplugged.
- This machine is manufactured with reusable materials. Please assist in proper disposal or recycling when disposing to protect the environment.
- This machine may be subjected to changes in structure and performance parameters in the future without prior notice.

Content

Safety Instructions	2~5
Installation Instructions	5~7
Product Description	8
Accessories	8
Control Panel	9~10
General Usage	11
Detergent And Load Recommendations	11~12
Cycle Selection Guide	13~14
Duvet Cycle	15
Wash + Airdry Cycle	15
Wool Cycle	16
Functions	16~17
Troubleshooting Guide	18
Non Fault Conditions	19
Care And Maintenance	19~20
Responsible Disposal	20
Specifications	21

Safety Instructions

IMPORTANT SAFETY INSTRUCTIONS READ CAREFULLY AND KEEP FOR FUTURE REFERENCE

Read this manual thoroughly before first use, even if you are familiar with this type of product. The safety precautions enclosed herein reduce the risk of fire, electric shock and injury when correctly adhered to.

Keep the manual in a safe place for future reference, along with the completed warranty card and purchase receipt. If applicable, pass these instructions on to the next owner of the appliance.

Always follow basic safety precautions and accident prevention measures when using an electrical appliance, including the following:



WARNING This heading indicates that there is a serious risk of injury if you do not adhere to the warning(s).



CAUTION This heading indicates that care should be taken to avoid injury to persons or damage to property.



A tick in a circle accompanies a measure or action that you should do or follow.



A cross in a circle accompanies a measure or action that you should NOT do.

- This appliance has not been designed for commercial applications.
- This appliance is intended to be used in household and similar applications such as:
 - farm houses
 - by clients in serviced apartments, holiday apartments and residential type environments
- This appliance is not intended for use by persons (including children) with reduced physical, sensory or mental capabilities, or lack of experience and knowledge, unless they have been given supervision or instruction concerning use of the appliance by a person responsible for their safety.
- Children should be supervised to ensure they do not play with the appliance.
- If the supply cord is damaged, it must be replaced by the manufacturer or its service agent or a similarly qualified person in order to avoid a hazard.
- If the machine must be placed on carpet, make sure the ventilation openings in the base are not obstructed.
- Connect the washing machine to the water mains using new hose sets. Do not reuse old hose sets.
- Water pressures between minimum 30kPa and maximum 800kPa are acceptable.
- Maximum capacity of this washing machine is 9kg(VWED9002IG) or 11kg(VWED1102IG) or 12kg(VWED1202IG).

Electrical safety

- Before connecting and turning on the washing machine, ensure the electrical voltage and circuit frequency correspond to those indicated on the appliance.
- Only connect the washing machine to a grounded (earthed) electrical outlet.

Safety Instructions

- Do not insert any objects into the appliance.
- Do not kink or damage the power cord, and position it out of the way so no one steps on or places anything on the cord or against it.
- Do not overload the wall outlet. Overloading can result in fire or electric shock.
- Never use this washing machine with a power adaptor or an extension cord.
- Unplug the washing machine from the power supply before cleaning, servicing, maintenance or moving the appliance. Pull by the plug, not by the cord.
- After use, always unplug the appliance and turn off the water.
- **WARNING:** All electrical work must be done in accordance with local and national electrical codes as applicable and should be undertaken by licenced and qualified persons only.

Installation

- Install the washing machine on a flat surface to avoid overturning during use.
- Install the washing machine so that there is a distance of at least 200mm between the appliance enclosure and any external heat sources, such as appliances containing heating elements.
- Make sure that all water and electrical connections are made by qualified personnel only, observing local safety regulations and following the manufacturers instructions (see Getting Started: Installation).
- Improper installation may result in the risk of fire, electric shock and/or injury.
- We assume no liability for any eventual damages caused by improper installation.

Usage conditions and restrictions

- The appliance is designed for private domestic use only.
- Do not operate the appliance outdoors.
- Before loading the washing machine, always ensure no pet or young child has climbed into it.
- Make sure all pockets of clothing to be washed are empty. Hard, sharp objects such as coins, safety pins, bra wires, nails, screws or stones can cause extensive damage to the appliance and block the pump.
- Any damage or malfunction resulting from foreign objects is not covered by your warranty and may lead to expensive repairs.
- We assume no liability for any eventual damages caused by improper or faulty use.

Cleaning and maintenance

- Before cleaning or carrying out maintenance, always unplug the appliance from the power supply.
- Except for the filters that require regular cleaning, the unit has no user-serviceable parts contained within. Do not attempt to repair, disassemble or modify it. Repairs made by inexperienced or unqualified persons may cause injury and/or make more serious repairs to the appliance necessary.
- **CAUTION:** After each wash, check and clean the lint filter inside the drum. Also check and clean the lint filter at the back of the machine next to the drain hose outlet on a regular basis.
- This appliance should only be serviced by an authorised service centre, and only genuine spare parts should be used. Contact the after sales support line for advice.

Safety Instructions

⚠️ WARNINGS

Regularly clean the power plug to remove dust and dirt and avoid contact failure.



Do not wash clothes that have residue of flammable materials.



Turn the machine off before pulling out the plug from the socket if the machine is not in use.



Do not let children climb into the washing machine or peer into the rotating spin barrel.



Insert the power plug securely.



Do not place any flammable items on top of the washing machine.



Use a 220-240V AC power source.



Do not use the appliance if the power cord or plug is damaged to avoid an electric shock, short circuit or fire.



To avoid electric shock, fire and malfunction, do not install this machine in a damp place.



No dampness



Do not pull out or insert the plug with wet hands to avoid electric shock.



No wet hands



⚠️ CAUTIONS

Ensure the water inlet hoses are connected and the taps are turned on before washing a load.



Do not allow children to lay or sit on top of the washing machine.



Do not change the power cord. If it needs changing, contact a qualified electrician or call the after sales support line.



Safety Instructions

Do not wash water-proof clothing in the washing machine.



Do not pull the power cord when removing the plug.



The water temperature should not exceed 60°C when washing with warm water.



Installation Instructions

Unpacking

- This product has been packaged to protect it against transportation damage. Keep the original packaging carton in a safe place. It will help prevent any damage if the product needs to be transported in the future. In the event that it is to be disposed of, please recycle it and all other packaging materials where possible.
- Plastic wrapping can be a suffocation hazard for babies and young children, so ensure all packaging materials are out of their reach and disposed of safely.
- Unwind the power cord to its full length and inspect it for damage. Do not use the appliance if the appliance or its cord has been damaged or is not working properly. **In case of damage, contact our after sales support centre for advice on examination, repair or return of the damaged product.**
- Read this manual to familiarise yourself with all the parts and operating principles of the washing machine. Pay particular attention to the safety instructions on the previous pages.

Transportation

At least two people are needed to carry the machine. One person on one side carries the cabinet handles.

Before handling or tilting the machine, secure the top cover of the washing machine is closed to avoid danger (such as using tape to close it).

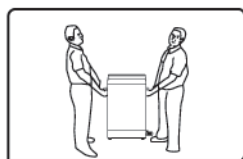

Installation of Bottom Cover

1. Take out the bottom cover on the washing machine surface protection rack and the screws in accessories bag.

2. Tilt the washing machine backwards and slowly lay it down on the cushion.

Note: Before tilting the machine, ensure that the top cover of the washing machine is closed (such as using tape).

3. Push the bottom cover straight into the base slot until it is seated in position.

4. Fix the bottom cover to the base with screws.

5. Lift up the washing machine gently and make it stand steady.

Note: Please be sure to install the bottom cover in place before using.

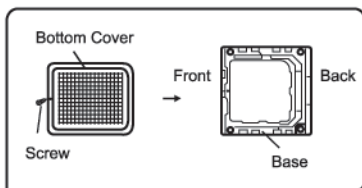

Installation Instructions

Location of the washing machine

1. Choose a dry place out of sunlight to place the washing machine.
2. Place the washing machine on a solid, stable floor.
3. The floor where the washing machine is installed should have a floor drain, and the floor drain should be unobstructed. At the same time, the floor drain should be flat with or slightly lower than the surface on which the washing machine is installed to prevent water leakage of the washing machine and cause harm.
4. Make the washing machine stand as stable as possible. If necessary, level the washing machine by adjusting the adjustable feet in the order shown. The maximum allowable inclination of the washing machine placement surface is 2°.
5. Minimum installation distance from the wall or installation cabinet is 10cm.

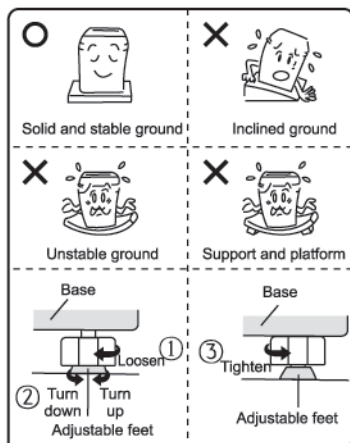

- Note:**
- When the washing machine is placed on the floor or a flexible support, vibration of the washing machine may be caused.
 - Installing the washer on a carpeted floor may cause vibration issues. If you must install it on carpet, make sure not to block the ventilation openings on the bottom of the washer.

Connecting the water inlet hoses

Install the water inlet hoses to your hot and cold water taps, as described below.

- Check and ensure that the sealing washers are firmly in place.
- Attach the straight end of the hose to your water taps. Make sure to attach the hot water supply hose (with red markings) to the hot water tap and the cold water supply hose (with blue markings) to the cold water tap.
- Tighten the coupling nuts securely by hand, as illustrated on the right (the sealing washer is part of and located inside the tap end).
- Attach the curved end of the hose to the corresponding inlet valve of the washer.
- Tighten the coupling nuts securely by hand, as illustrated below.
- Tighten the nut by turning it clockwise while holding the hose. (To detach the water supply hose, turn the nut anticlockwise after turning the tap off.)

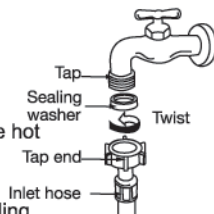

- Turn on the taps and check for leaks. Tighten the coupling nuts firmly if there is any leakage. If your water pressure is strong, close the water tap completely, then open it slightly.

IMPORTANT!

Both the hot water and cold water hoses must be connected to your taps.
Make sure your hot water from the tap is no hotter than 60°C.

- CAUTION!** When tightening the clamping nut, take care not to damage the water inlet valve joint. Apply force evenly and do not twist the water inlet valve.

Installation Instructions

CAUTION! Use only the new (supplied) hoses with your new appliance. Do not use a hose from an existing machine, or one that has been used previously.

CAUTION! In the event that the hoses are too short for your set-up, please seek advice from your local washing machine store to purchase a longer hose.

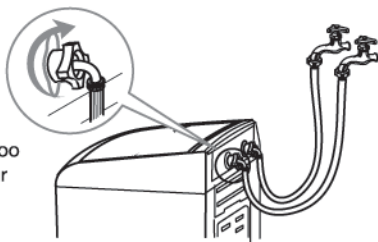

Installing the drain hose

- The drain hose and drain pump filter are located at the back of the machine, as illustrated below, left.
- Pinching the two bands of the clamp on the drain hose, connect it to the drain hose connection at the back of the washer, as illustrated below.
- When the washer is in use, put the drain hose into a drain spout (or into a sink/tub).

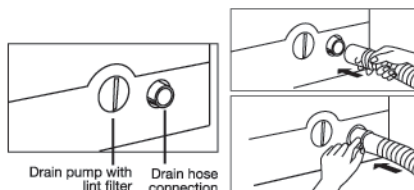

CAUTION!

- While the washer is in use, make sure the height of the drain hose is at least 80cm, otherwise the washer will not work well, or the water may flow out in the course of washing. Also ensure the drain hose is not higher than 120cm above ground, otherwise the washer will not drain water well.
- Never lay down the drain hose, as water will be discharged.
- Be sure the drain hose is properly routed so it will not kink or lift off the sink.

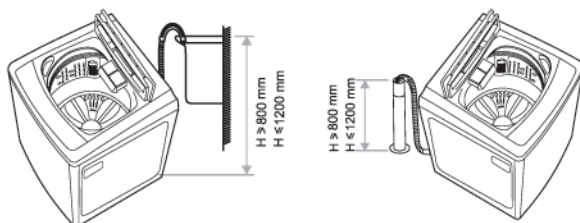

Using the rollers

The washing machine is equipped with two rollers at the back that you can use to move the machine more easily. Tilt the washing machine by about 30 degrees and push forward, or pull backward, while holding the machine securely on both sides with your hands, as illustrated below.

Do not move the machine on the rollers on uneven ground, which can damage the rollers.

CAUTION: Take care of your back! Do not tilt the washing machine too much, which could cause injury.



Product Description

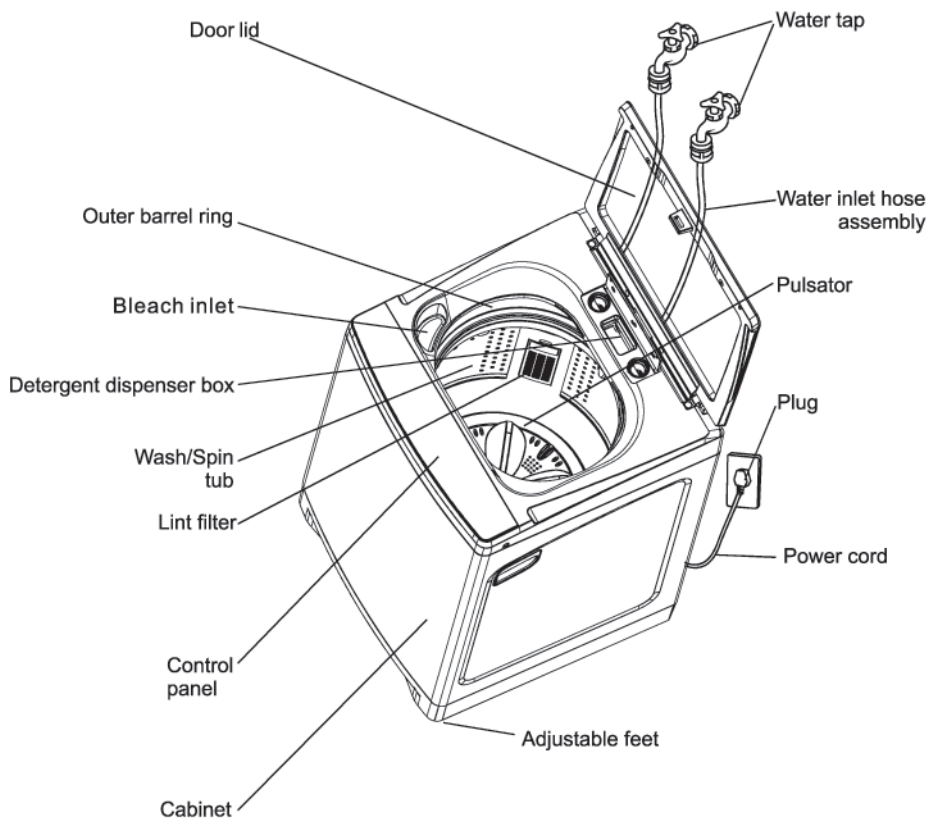

Picture for reference only, please refer to the actual product.

Accessories

Instruction manual	Drain Hose	Cold water Supply Hose	Hot water Supply Hose	Bottom Cover	Screw	Warranty Card
	 Hose Band					

Control Panel

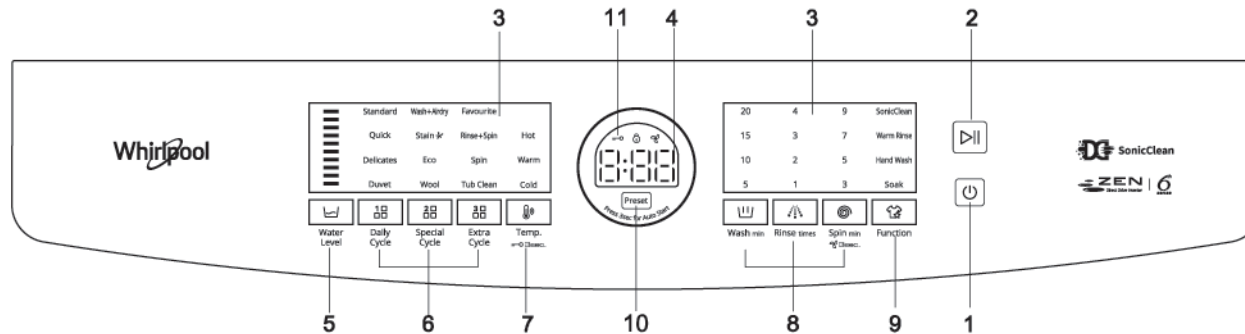

*Note: Above panel for reference only, please refer to actual product

1. Power ON/OFF Button

- Press this button to switch on the washing machine. To switch off the power, press it again. If idle for 10 minutes after machine is turned on, the power will be automatically cut off. After washing program finishes, the power will be cut off automatically after 5 seconds.

2. "Start/Pause" Button

- Press this button to start the wash cycle. Press once to pause the operation, to resume, press the same button again.

3. Setting display window

- When the power is turned on, it displays settings such as wash cycles, washing time, rinse times, spinning time etc.
- During the setting process, the item you selected will be displayed.

4. Digital display window

- The remaining time is displayed during operation. Example: 20 minutes remaining. ----- 0:20
- If preset function is selected, it shows when the cycle is set to be completed. Example: Complete in 2 hours:----- 2H
- When the child lock function is set, the child lock indicator lights up. -----
- When an error occurs, a fault code is displayed. Example: No water intake: ----- E I
Note: Fault code with 4 digits (e.g E901) will be displayed alternatively.
- After the washing machine has started, the door lock will be activated and the door lock indicator will light up. -----

5. Water level Button

- Press the button to select the suitable washing water level (1-10, by sliding the water level gear).
- Not applicable for some cycles.
- The water level can be set after operation started.

6. "Cycle" Buttons

You can select the desired wash cycle by pressing one of the "Cycle" button.

7. "Temp." Button

Press Temp. button to choose cold, warm or hot water washing.

8. "Option" Buttons

You can freely set the washing time, rinse times, spinning time according to your needs.

9. "Function" Button

You can freely choose the functions Soak, Hand Wash, Warm Rinse and SonicClean according to your needs.

10. Preset Button

- After power on, press the "preset" button to set the delay function, and preset the time from the start to the end of program.
- Delay time can be set from 1-24 hours.
- In shutdown mode press and hold the button for 3 seconds to auto start a predefined cycle.

11. Child lock indicator

- After the child lock function is turned on, the child lock indicator lights up. All buttons will not respond except for the "Power On / Off" button.

General Usage

Before you start washing

- A Make sure the washer is stable and level.
If necessary, adjust the adjustable leg (front right) to stabilise the washer.
- B Make sure the water inlet hoses are properly installed.
- C Plug the machine into a nearby power point.
- D Open the water taps.
- E Make sure the drain hose is properly installed. Hang the upper end of the hose over the laundry sink or into a drain spout.
- F Before using the washing machine for the first time, run a complete cycle without laundry items.

Select the **Standard** cycle and run the machine until the end of the cycle.

Normal usage

1. Before washing, remove any coins, keys and other hard items from pockets. Close any zippers to prevent damaging your clothes and the wash tub. Brush dirt and sand off clothes and turn pockets inside out.
2. Sort your washing into appropriate loads: whites, coloureds, cottons, delicates, heavily soiled, etc. Place delicate items into a wash bag for protection.
3. Load your washing items uniformly in the tub.
4. Add washing detergent (see section Detergent and Load Recommendations).
5. Press the **Power** button.
6. Refer to the cycle Selection Guide and select a suitable wash cycle.
7. Close the lid and press the **Start/Pause** button. (If the washer lid is not closed properly, the washer will not be able to complete the washing process normally and there will be alarm alert.)
8. At the end of the wash, remove your washing, unplug the power plug from the wall outlet and close the water taps. Leave the lid open until the interior has dried.

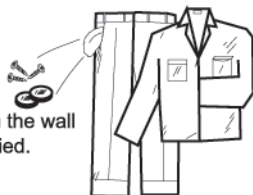
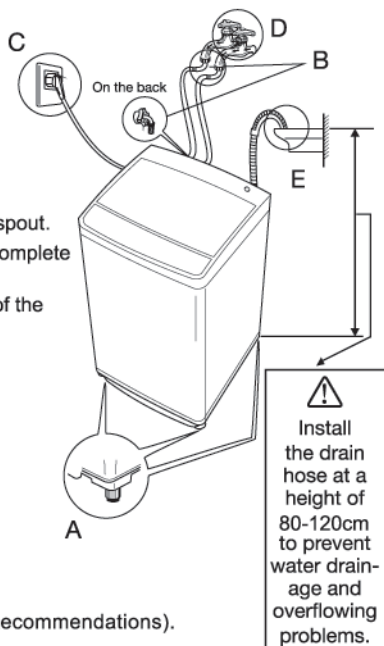

Detergent And Load Recommendations

Detergent box



Before washing, the liquid detergent, washing powder and softener should be added into the corresponding compartment as per needed.

During the washing process, it will be automatically added to the tub.

Designed to use only HE High Efficiency detergents.

Note the following instructions:

- Washing powder compartment:

- ① Please add a proper amount of washing powder according to the loading, the selected water level, the degree of soiling of the laundry and the instruction manual of the washing powder you choose;
- ② If delay function is set, it is recommended to put the washing powder directly into the compartment in advance;

Detergent And Load Recommendations

- ③ It is recommended not to use high foaming washing powder, so as keep good washing effect or to avoid foaming overflow;
- ④ Washing powder with bad quality may coagulate in the compartment, please clean it periodically .
- Liquid detergent compartment: Pour the liquid detergent here, and do not exceed the MAX line.
 - Softener compartment: Pour the softener here, and do not exceed the MAX line.
- * Note: The siphon cover cannot be removed during washing.

How to use laundry detergent when select preset function

- Washing powder can be placed directly in the washing powder dispenser or wrapped in a towel and placed directly in the tub.
- Liquid detergent and bleach can be poured directly into the holes on top frame, but not directly on the clothing, otherwise it may cause clothing color to fade.
- Dilute the softener two times and pour into the softener dispenser box.
- Please do not use saponin tablets, because it does not dissolve easily and will affect washing effect.

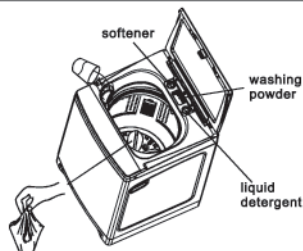

VWED9002IG Laundry Detergent and Water Consumption						
Water level						
Powder laundry detergent dosage(g)	20~30		30~35	35~40	40~50	50~60
Other types of laundry detergent	Use according to the corresponding laundry detergent instructions					

VWED1102IG Laundry Detergent and Water Consumption						
Water level						
Powder laundry detergent dosage(g)	15~25		25~35	35~45	45~60	60~70
Other types of laundry detergent	Use according to the corresponding laundry detergent instructions					

VWED1202IG Laundry Detergent and Water Consumption						
Water level						
Powder laundry detergent dosage(g)	30~40		40~50	50~60	60~70	75~80
Other types of laundry detergent	Use according to the corresponding laundry detergent instructions					

If the amount of detergent is too much, there may be residues, while if it is too little, the laundry may not be clean.

Cycle Selection Guide

Cycle	Description	Maximum washing capacity	Approximate duration/min			Water Level	Standard setting			Function					
			VWED9002IG	VWED1102IG	VWED1202IG		washing / min	rinsing / times	spinning / min	Preset	Child Lock	Soak	SonicClean	Warm Rinse	Hand Wash
*Standard	Suitable for washing normally soiled cotton and linen load	Rated Capacity	47-68	50-77	50-74	Default: automatic Range:1-10	6-15	2	7	●	●	●	●	●	●
Quick	Suitable for quick washing of lightly soiled clothes	≤3kg	27-35	29-41	29-39	Default: automatic Range:1-10	5	1	3	●	●	○	●	●	○
Delicates	Suitable for gentle washing of fine fabrics	≤3kg	34-46	37-55	37-52	Default: 7 Range:3-10	5	2	3	●	●	○	●	●	○
Duvet	Suitable for washing large household textiles	Rated Capacity 70%	80-88	88-100	88-96	Default: 10 Range:5-10	15	3	9	●	●	●	●	●	○
Wash + Airdry	It is suitable for fast washing and air drying of a small loading of lightly soiled clothes, reducing the amount of water remaining in the clothes and saving your time for line drying	≤3kg	54-62	56-68	56-66	Default: automatic Range:1-10	5	1	30	●	●	○	●	●	○
Stain ✂	Cold water stain removal cycle	≤3kg	61-73	64-82	64-79	Default: automatic Range:1-10	20	2	7	●	●	●	●	●	○
Wool	Suitable for washing machine washable wool clothing	≤3kg	34-46	37-55	37-52	Default: 7 Range:3-10	5	2	3	●	●	○	●	●	○
Eco	It is suitable for washing mixed fabrics. It's an effective cycle to reduce energy consumption	Rated Capacity	61-73	64-82	64-79	Default: automatic Range:1-10	20	2	7	●	●	●	●	●	○
Favourite	Suitable for the washing of cotton and linen fabrics, the set parameters (washing time, rinse times, spinning time) will be memorized	Rated Capacity	47-68	50-77	50-74	Default: automatic Range:1-10	6-15	2	7	●	●	●	●	●	●
Rinse + Spin	For clothing that only needs to be rinsed and spinned	Rated Capacity 70%	24-28	25-32	25-30	Default:10 Range:1-10	—	1	7	●	●	○	○	●	○
Spin	For clothing that only needs to be spinned	Rated Capacity 70%	10	10-11	10	—	—	—	7	●	●	○	○	○	○
Tub clean	The inner tub is cleaned by washing it for a long time	—	116	122	120	Default: 10	85	1	3	●	●	○	●	○	○
Air dry	Use it independently after washing, reduce the amount of residual water and save your time for line drying(long press Spin button to activate)	3kg	15-30-45-60			—	—	—	—	●	●	○	○	○	○

- Based on the water pressure or the type of loading,etc.,the actual washing time is slightly different from the time shown in the above table.
- If the load is not placed according to the recommended washing capacity,the expected washing effect may not be achieved.
- If you choose different washing time,rinse times,spinning time parameters and function options,the displayed time will be different.

*Test wash cycle in compliance with regulation AS/NZS 2040.1 and AS/NZS 2040.2:
 VWED9002IG/VWED1202IG:Standard, water level "6",rinse "3 times",Warm Temperature.
 VWED1102IG:Standard,water level "8",rinse "3 times",Warm Temperature.

●	None by default, selectable
○	None by default, not selectable

Duvet Cycle

- When using this cycle, the water level is automatically set to level 10, and you can set the appropriate water level within the allowable range according to your needs.

How to use (Take the washing of blankets as an example)

1. Open the washing machine lid and press the "Power On / Off" button.
2. Select "Duvet" cycle, the cycle light is on.
3. Add detergent in the detergent box or directly into the tub.
4. Add blanket into the washing machine.



Fold in two by the long side



Fold 4 times in the same direction



Roll up the blanket.



Pour it into the wash tub with the edge downwards

5. Close the lid.
 - If the lid of the washing machine is not closed, the washing machine will not be able to complete the washing process normally and there will be an alarm alert.
6. Press the "Start/Pause" button. (If necessary, the water level can be adjusted manually)
 - After the washing is completed, the buzzer will ring and the power will be cut off automatically.
 - After washing, turn off the water tap and clean the filter.
7. Cycle finished.
 - Take out the blanket and hang it up for line drying.

NOTE:

- Pre-wash soiled parts by hand.
- Do not use too much detergents.
- Stains are effectively removed with warm water.
- During the washing process, if part of the blanket is spill outside water, press the "Start/Pause" button, the washing machine will stop running temporarily, press the part back in, and press the "Start/Pause" button again to continue washing.
- This cycle is not applicable for down jackets.

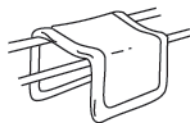

Wash + Airdry Cycle

- It is suitable for quickly air drying lightly soiled clothes using fresh air blown in, reducing the amount of residual water in the clothes and saving your time for line drying.
- The spinning time is fixed as 30 minutes and cannot be adjusted.
- The washing capacity should be below 3kg.

How to use

1. Open the washing machine lid and press the "Power On / Off" button.
2. Select "Wash+Airdry" cycle, the cycle light is on.
3. Add detergent in the detergent box or directly into the tub.
4. Add laundry into the washing machine.
5. Close the lid.
 - If the lid of the washing machine is not closed, the washing machine will not be able to complete the washing process normally and there will be an alarm alert.
6. Press the "Start/Pause" button. (If necessary, the water level can be adjusted manually)
 - After the washing is completed, the buzzer will ring and the power will be cut off automatically.
 - After washing, turn off the water tap and clean the filter.

Wool Cycle

- Please check the washing label on clothes before washing.
- When using this cycle, the water level is automatically set to level 7, and you can set the appropriate water level within the allowable range according to your needs.

How to use

1. Open the washing machine lid and press the "Power On / Off" button.
2. Select "Wool" cycle, the cycle light is on.
3. Add detergent in the detergent box or directly into the tub.
4. Add laundry into the washing machine.
5. Close the lid.
 - If the lid of the washing machine is not closed, the washing machine will not be able to complete the washing process normally and there will be an alarm alert.
6. Press the "Start/Pause" button. (If necessary, the water level can be adjusted manually)
 - After the washing is completed, the buzzer will ring and the power will be cut off automatically.
 - After washing, turn off the water tap and clean the filter.

Note

- Washing capacity should be below 3kg.
- After the program is finished remove clothes from the tub and lay flat to dry them, to prevent odor and wrinkles.
- Wash white or light colored clothing separately from dark colored clothing.
- The use of special detergent for wool is recommended for a better washing effect.

Functions

Preset function

- The delay time is the time from the start to the end of cycle.
- Before setting the delay time, first turn on the water tap, lay down the drain hose, and check whether the universal joint is tightened to prevent water leakage.

How to use

1. Open the lid and press the "Power On / Off" button.
2. Add laundry into the washing machine.
3. Select the appropriate cycle, function and water level as per need.
4. Press the "Preset" button to set the delay time.
 - Delay time can be set from 1-24 hours.
5. Add detergent and cover the lid.
 - When you set a delay time, add detergent, washing powder, and softener into the corresponding detergent compartment.
6. Press the "Start/Pause" button.
 - After about one minute, all other lights will turn off except for the cycle light, door lock light, and appointment time light. (If the child lock function is set, the child lock light is on.)
 - To view the selected cycle, press any button except the "Power On/Off" button. The selected cycle will be displayed for 5 seconds.
 - To change the selected cycle, turn off "Power On/Off" and restart the settings.
 - The function will be cancelled after unplugging power cord or power failure.

Functions

Child lock function

This function prevents improper use (by children). After the child lock function is turned on, all other buttons will not respond except the "Power On/Off" button.

- Setting child lock function: Press the "Power On/Off" button. After turning on the power, press and hold the "Temp." button for 3 seconds until you hear a beep sound, the child lock function is activated. To cancel repeat the above steps.

SonicClean function

- Select the "SonicClean" function to turn on the ultrasonic function during the washing process, and the in-built generator will form fine bubbles to enhance the washing effect, remove stains, better dissolve and hence saving the use of washing powder.
- Some cycles cannot set this function.

Soak function

- Select the soaking function to allow the detergent to fully dissolve and penetrate into the clothes, reducing the adhesion of stains to the clothes, and enhance cleaning effect.
- After selecting the soaking function, soaking phase will be added before main wash (Quick, Delicates, Wash+AirDry, Wool, Tub Clean, Rinse+Spin, Spin, Air Dry cycles do not have this function).
- The soaking time is 20 minutes. During dynamic soaking, the first 5 minutes is 3 minutes of washing and 2 minutes of set (no movement), and then 1 minute of washing and 4 minutes of set each time.

Hand Wash function

- Select the "Hand Wash" function, it works by the imitation of hand wash by water flow for enhanced washing performances.
- Some cycles cannot set this function.

Warm Rinse function

- Select the "Warm Rinse" function to change water storage rinse of the current cycle to cold and hot water together.
- Some cycles cannot set this function.

Change the settings of a running cycle

- After a cycle started, the parameters that have not been run can be changed at any time without having to turn off the power to set again.
- This function is limited to non-running parameters. For example, during the washing phase, you could press the "Rinse" button to set the number of rinse times.

Troubleshooting Guide

When the following problems occur, the microcomputer will detect the abnormal state and issue an electronic buzzer alarm, and the digital window will display the status as shown in the table below.

Note:

After checking each item and removing the fault, press the "Start / Pause" button, the fault code should be cleared, and the washing machine will continue to run. If it is still abnormal, please unplug the power plug and contact After-sales Service as soon as possible.

Failure type	Failure Display	Reason
Not working at all		<ul style="list-style-type: none"> • Whether the power is connected? • Whether the "Start / Pause" key is pressed? • Whether the preset function has been set? • Whether the fuse or current breaker of the power supply intact? • Whether there is a power outage?
No water intake or litter water inflow	E1	<ul style="list-style-type: none"> • Whether the water tap is turned on? • Whether the water supply is cut off? • Whether the water inlet hose and water inlet valve filter is blocked? • Whether the water inlet hose of the washing machine is frozen? • Whether the water pressure too low and the water intake time is too long?
Drainage failure	E2	<ul style="list-style-type: none"> • Check and make sure the drain hose is properly connected and installed. • Check the drain hose for kinks or obstructions. • Check whether the drain hose is clogged. • Check and ensure that the drain hose is between 80cm and 120cm off the ground. • Check whether the filter of the drain pump is clogged. • Check the lint filter bag inside the drum is clean. • Check the lint filter at the lower back of the machine is not obstructed.
Not Spin	E3	<ul style="list-style-type: none"> • Whether the laundry is leaning to the side of the tub? • Whether the washing machine is installed flat?
	E4	<ul style="list-style-type: none"> • Whether the washing lid is open?
Others	EA Eb EC	<ul style="list-style-type: none"> • Please press the "Power On/Off" button to turn off the power, unplug the power cord, and contact After-sales Service as soon as possible.
	E901 E902 E920 etc.	
	Ed	

None Fault Conditions

1. Sometimes there are water intake during washing or rinsing. This is the automatic water replenishment due to a drop of water level.
2. At the beginning of spinning, the washing machine tub stops and rotates from time to time. This is an intermittent process designed to achieve better performance.
3. When rinsing with water overflowing, water may not drain due to low water level or water pressure.
4. Water intake and rinsing sometimes occurs during spinning process, this is due to the lean-correction of the clothes performed automatically during the dehydration.
5. During the spinning process, if unbalance happened, in order to prevent water and electricity waste, the washing machine will attempt to auto-correct for two times, and will display E3 fault code if all attempts failed, requiring manual adjustment of loads before restarting the washing machine.
6. After the spinning is over, there is a sound of water remaining. This is the sound of the balance fluid flowing in the balance ring designed to reduce the dehydration vibration.
7. If the power is cut off during the operation, then the operation will be continue automatically after power is resumed, in this event, reset it.
8. When the washer lid left open for more than 10 minutes, the water will automatically drain and wash program will be stopped. Please set the program again.

Care And Maintenance

Cleaning the lint filter (suggested interval: every week)

Take out the lint filter as illustrated on the right. Open the filter and rinse it clean under running water, taking care not to damage any parts. Reinstall the filter, making sure it fits securely behind the cover clasp and latches and locks securely into place.

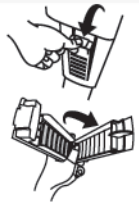

Cleaning the water inlet valve (suggested interval: every 6 months)

To avoid blockage of the mesh filter at the water inlet after long time use, detach the water inlet hose, making sure you have turned off the water supply at the taps beforehand. Take the mesh filter out of the water inlet valve and clean the filter with a soft brush. Then assemble the mesh filter back into the valve and reconnect the water inlet hose.

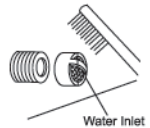

Cleaning the hose filter (suggested interval: every 6 months)

To avoid blockage of the hose filter after long time use, detach the water inlet hose, making sure you have turned off the water supply at the taps beforehand. Turn the nut anticlockwise to take off the hose, clean the filter under running water or with a soft brush, then reconnect the hose.

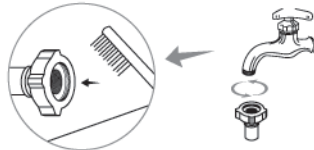

Drain pump maintenance

We recommend that you clean the drain pump filter regularly (at least once a month) to avoid blockages created by bobby pins, coins and excess lint.

Proceed as follows:

1. Disconnect the washer from the power source.
2. If necessary, wait until the water has cooled down.

Care And Maintenance

3. Place a container underneath the pump opening to collect any spillage.
4. Turn the filter cap anticlockwise to take it out gently . Always keep a rag nearby to dry up water spillage when removing the pump filter.
5. To remove any objects from the filter, wash it thoroughly in a basin or under running water.
6. Put the cap back and place the filter back in its seat.

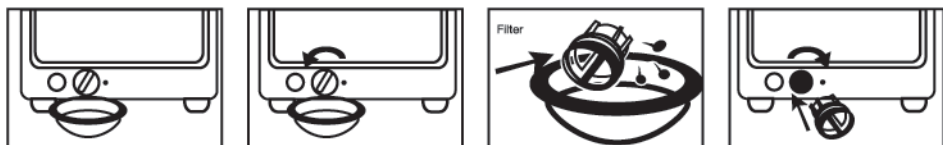

Storage

If the appliance is not going to be used for an extended period of time, please unplug the machine from the power supply and disconnect all hoses. Clean the machine and filters as described on the previous pages. Let the machine air-dry thoroughly. Then store it in the original packaging in a dry location, out of reach of children.

IMPORTANT

If you frequently use a COLD wash cycle, you will need to clean the inside of your washing machine regularly (every three months), especially if you use a fabric softener. Liquid detergents can cause detergent scum to build up around the outside of the inner tub, which cold water will not remove and which can cause bacteria, unpleasant odours, and eventually soiling of your wash load.

To remove scum build-up from the inside of a washing machine, run a cleaning cycle without clothes using the **Duvet** program and **hot** water.

As a cleaning agent, use a commercially available washing machine cleaning product (such as **Trimat Washing Machine Cleaner**) according to the instructions on the product), or use a mix of bicarbonate of soda ($\frac{1}{2}$ cup) and white household vinegar (2 cups).

Responsible Disposal

Packaging materials are recyclable. Please dispose of them responsibly for recycling.

At the end of its working life, do not throw this appliance out with your household rubbish. Electrical and electronic products contain substances that can have a detrimental effect on the environment and human health if disposed of inappropriately. Observe any local regulations regarding the disposal of electrical consumer goods and dispose of it appropriately for recycling. Contact your local authorities for advice on recycling facilities in your area.

Specifications

Model no.	VWED9002IG	VWED1102IG	VWED1202IG
Rated washing capacity	9kg	11kg	12kg
Rated spin capacity	9kg	11kg	12kg
Rated voltage and frequency	220-240V~50Hz	220-240V~50Hz	220-240V~50Hz
Rated Power	400W	400W	500W
Net weight	47kg	55kg	65kg
Water pressure	0.03~0.8MPa	0.03~0.8MPa	0.03~0.8MPa
Net Dimensions (mm)	601Wx626Dx1010H	601Wx626Dx1030H	680Wx710Dx1055H